

Long Sensing Distance Type

Long sensing distance proximity sensor

■ Features

- Longer sensing distance up to 25mm
- Improved the noise resistance with dedicated IC
- Reverse power polarity, surge, overcurrent protection
- Long life cycle and reliable
- Red LED status indication
- IP67 rated waterproof structure (IEC standard)
- Replacer for micro switches and limit switches



⚠ Please read "Caution for your safety" in operation manual before using.



■ Specifications

● DC 3-wire type

| Model | PRD12-4DN PRD12-4DP PRD12-4DN2 PRD12-4DP2 PRDS12-4DN PRDS12-4DP PRDS12-4DN2 PRDS12-4DP2 PRDW12-4DN PRDW12-4DP PRDW12-4DN2 PRDW12-4DP2 | PRD12-8DN PRD12-8DP PRD12-8DN2 PRD12-8DP2 PRDS12-8DN PRDS12-8DP PRDS12-8DN2 PRDS12-8DP2 PRDW12-8DN PRDW12-8DP PRDW12-8DN2 PRDW12-8DP2 | PRD18-7DN PRD18-7DP PRD18-7DN2 PRD18-7DP2 PRDL18-7DN PRDL18-7DP PRDL18-7DN2 PRDL18-7DP2 PRDW18-7DN PRDW18-7DP PRDW18-7DN2 PRDW18-7DP2 PRDWL18-7DN PRDWL18-7DP PRDWL18-7DN2 PRDWL18-7DP2 | PRD18-14DN PRD18-14DP PRD18-14DN2 PRD18-14DP2 PRDL18-14DN PRDL18-14DP PRDL18-14DN2 PRDL18-14DP2 PRDW18-14DN PRDW18-14DP PRDW18-14DN2 PRDW18-14DP2 PRDWL18-14DN PRDWL18-14DP PRDWL18-14DN2 PRDWL18-14DP2 |
|----------------------------------|--|--|--|--|
| Sensing distance | 4mm ±10% | 8mm ±10% | 7mm ±10% | 14mm ±10% |
| Hysteresis | Max. 10% of sensing distance | | | |
| Standard sensing target | 12×12×1mm (Iron) | 25×25×1mm (Iron) | 20×20×1mm (Iron) | 40×40×1mm (Iron) |
| Setting distance | 0 to 2.8mm | 0 to 5.6mm | 0 to 4.9mm | 0 to 9.8mm |
| Power supply (Operating voltage) | 12-24VDC (10-30VDC) | | | |
| Current consumption | Max. 10mA | | | |
| Response frequency(*1) | 500Hz | 400Hz | 300Hz | 200Hz |
| Residual voltage | Max. 1.5V | | | |
| Affection by Temp. | Within ±10% max. of sensing distance at +20°C in temperature range of -25 to +70°C | | | |
| Control output | 200mA | | | |
| Insulation resistance | Min. 50MΩ (at 500VDC mega) | | | |
| Dielectric strength | 1500VAC 50/60Hz for 1minute | | | |
| Vibration | 1mm amplitude at frequency of 10 ~ 55Hz in each of X, Y, Z directions for 2 hours | | | |
| Shock | 500m/s ² (50G) X, Y, Z directions for 3 times | | | |
| Indicator | Operating indicator (Red LED) | | | |
| Ambient temperature | -25 ~ +70°C (non-freezing condition) | | | |
| Storage temperature | -30 ~ +80°C (non-freezing condition) | | | |
| Ambient humidity | 35 ~ 95%RH | | | |
| Protection circuit | Surge, Reverse poser polarity, Overcurrent protection circuit | | | |
| Protection | IP67 (IEC Standard) | | | |
| Approval | CE | | | |
| Unit weight | PRD:Approx.74g PRDS:Approx.72g PRDW:Approx.44g | PRD:Approx.72g PRDS:Approx.70g PRDW:Approx.42g | PRD:Approx.115g PRDL :Approx.159g PRDW:Approx.80g PRDWL:Approx.110g | PRD:Approx.110g PRDL:Approx.140g PRDW:Approx.75g PRDWL:Approx.105g |

※(*1) The response frequency is the average value. The standard sensing target is used and the width is set as 2 times of the standard sensing target, 1/2 of the sensing distance for the distance.

(A) Counter

(B) Timer

(C) Temp. controller

(D) Power controller

(E) Panel meter

(F) Tacho/Speed/Pulse meter

(G) Display unit

(H) Sensor controller

(I) Switching power supply

(J) Proximity sensor

(K) Photo electric sensor

(L) Pressure sensor

(M) Rotary encoder

(N) Stepping motor & Driver & Controller

(O) Graphic panel

(P) Production stoppage models & replacement

PRD Series

■ Dimensions

(Unit:mm)

●PRD12-4D□

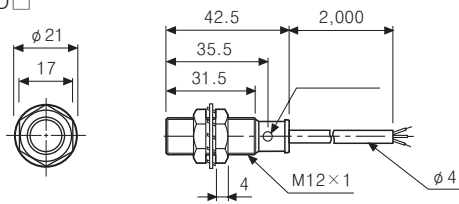

●PRD12-8D□

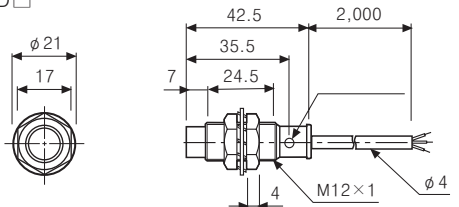

●PRDS12-4D□

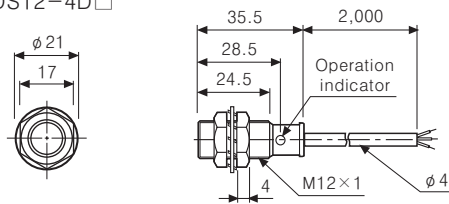

●PRDS12-8D□

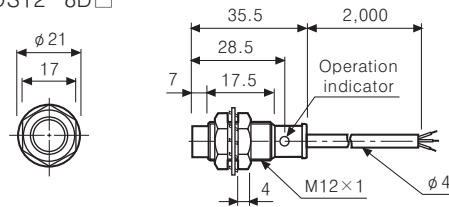

●PRD18-7D□

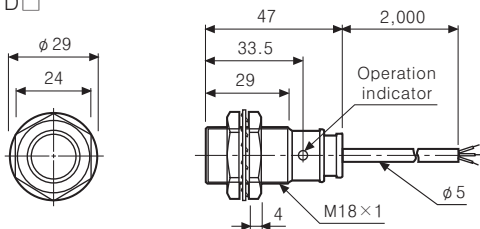

●PRD18-14D□

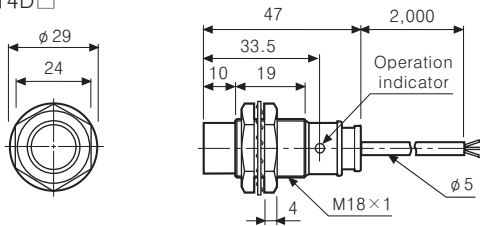

●PRDL18-7D□

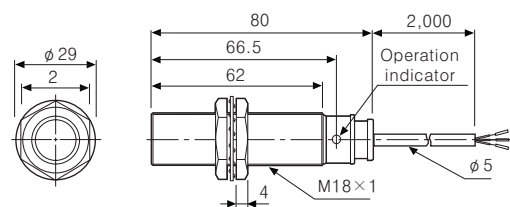

●PRDL18-14D□

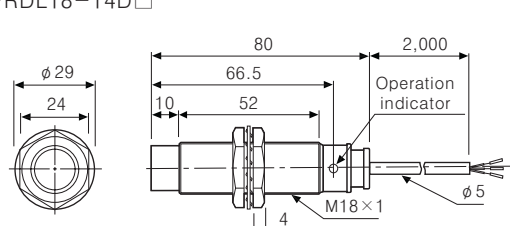

●PRDW12-4D□

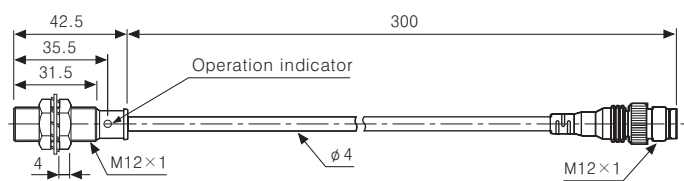

●PRDW12-8D□

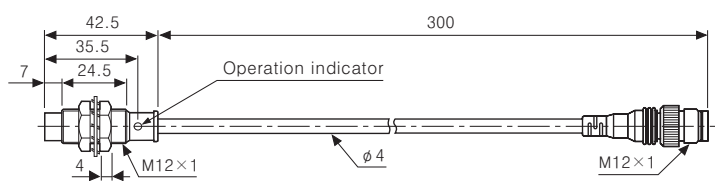

●PRDW18-7D□

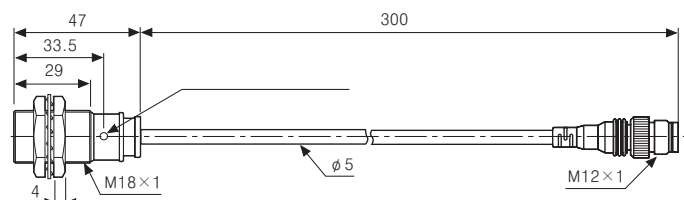
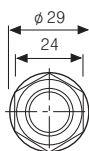
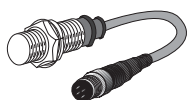

●PRDW18-14D□

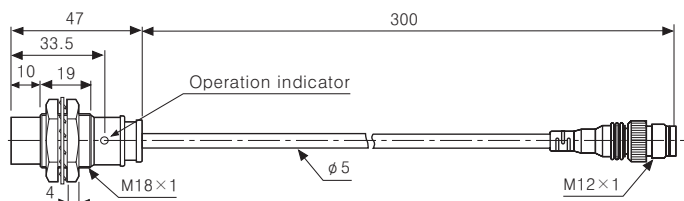
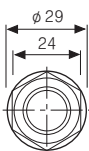
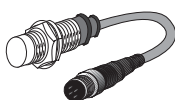

Long Sensing Distance Type

Dimensions

(Unit:mm)

●PRDWL18-7D□

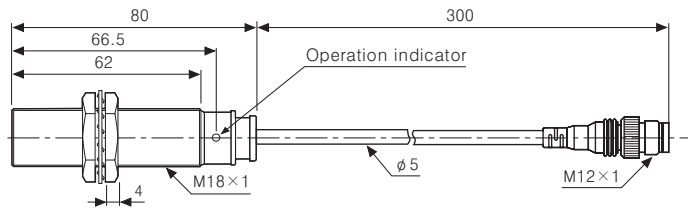
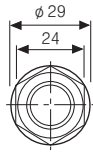
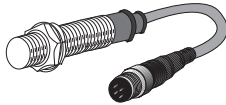

●PRDWL18-14D□

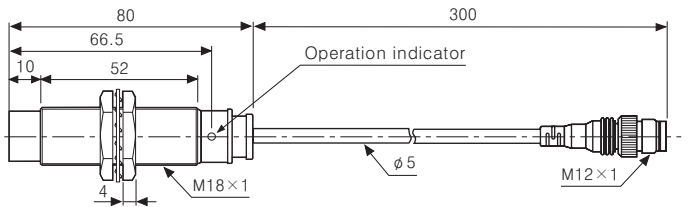
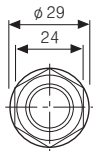
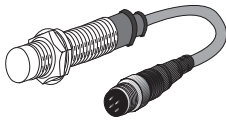

Control output diagram

◎DC 3-wire type

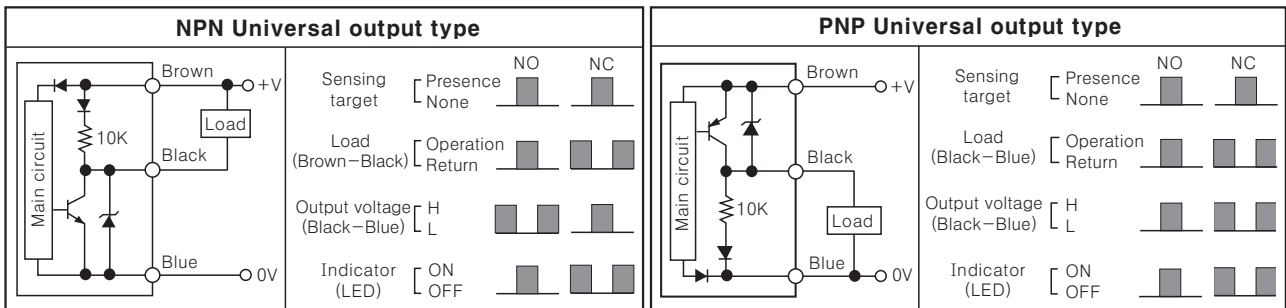

Connections

◎DC 3-wire type

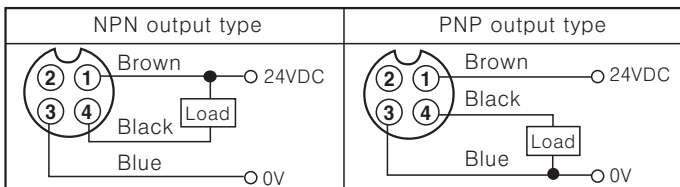

※Please fasten the cleat of connector not to shown the thread. (0.39~0.49N·m)

※Please fasten the vibration part with Teflon tape.

※See J-48 for IEC standard connector cables and specifications.

Proper usage

◎Mutual-interference

When several proximity sensors are mounted closely, malfunction of sensor may be caused due to mutual interference. Therefore, be sure to provide a minimum distance between the two sensors, as below charts.

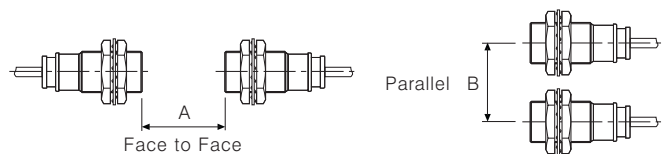

◎Influence by surrounding metals

When sensors are mounted on metallic panel, you must prevent the sensors from being affected by any metallic object except target. Therefore, be sure to provide a minimum distance as below chart.

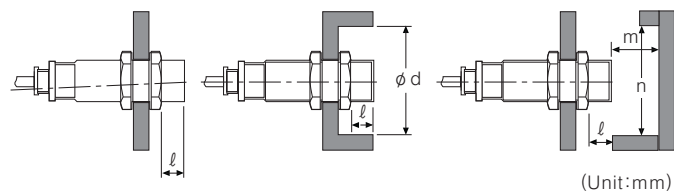

(Unit:mm)

| Item \ Model | PRD□12-4D□ | PRD□12-8D□ | PRD□18-7D□ PRDW□18-7D□ | PRD□18-14D□ PRDW□18-14D□ |
|--------------|------------|------------|---------------------------|-----------------------------|
| A | 24 | 48 | 42 | 84 |
| B | 24 | 36 | 36 | 54 |
| l | 0 | 11 | 0 | 14 |
| φd | 12 | 36 | 18 | 54 |
| m | 12 | 24 | 21 | 42 |
| n | 18 | 36 | 27 | 54 |

(A) Counter

(B) Timer

(C) Temp. controller

(D) Power controller

(E) Panel meter

(F) Tacho/Speed/Pulse meter

(G) Display unit

(H) Sensor controller

(I) Switching power supply

(J) Proximity sensor

(K) Photo electric sensor

(L) Pressure sensor

(M) Rotary encoder

(N) Stepping motor & Driver & Controller

(O) Graphic panel

(P) Production stoppage models & replacement